

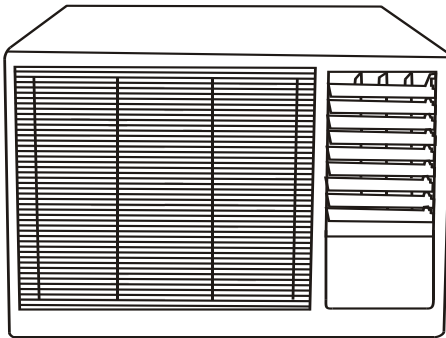

WINDOW TYPE AIR CONDITIONER

OWNER'S MANUAL

MODEL: DCB07(2.2kW Cooling / 2.05kW Heating)
DCB09(2.6kW Cooling / 2.4kW Heating)
DCB14(4.1kW Cooling / 3.6kW Heating)
DCB05C(1.6kW Cooling)
DCB07C(2.2kW Cooling)
DCB09C(2.7kW Cooling)



IMPORTANT

- Please read this owner's manual carefully and thoroughly before installing and operating your room air conditioner.
- Please retain this owner's manual for future reference after reading it thoroughly.

Table of Contents

	Page
Introduction	2
Operating Instructions	4
Electrical Specifications	5
Installation Instructions	6
Care and Maintenance	9
Trouble Shooting Guide	10

Introduction

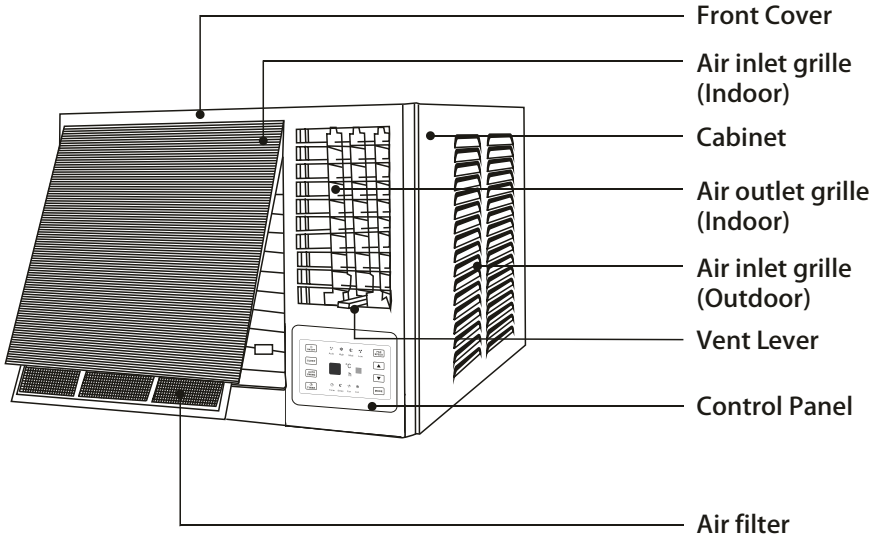
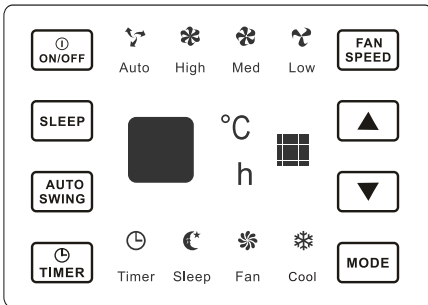
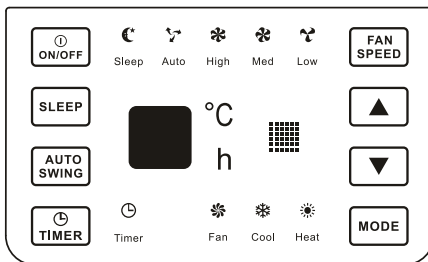

Fig.1-1



DCB05C/DCB07C/DCB09C



DCB07/DCB09

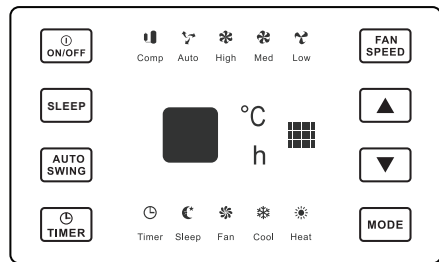









DCB14

Controller Panel











Operating Instructions

► For remote control model

You can easily operate this air conditioner by press relevant button on the control panel as well as the remote controller.

No.	Button	Function
1		• Used to adjust airflow direction.
2		<ul style="list-style-type: none"> • Used to set or cancel timer operation. • When the unit is in operation, you can set OFF TIMER. When the unit is off, you can set ON TIMER. Timer setting range is 0 to 24 hours. • If the OFF TIMER is set, the timer LED displays the remaining time to turn off the unit for only 10 seconds, then LED shifts to display set temperature. • If you press TIMER button within the 10 seconds, OFF TIMER will be canceled. • If the ON TIMER is set, the timer LED displays the remaining time to turn on the unit. If you want to cancel ON TIMER, press TIMER button.
3		• Everytime you press this button, the air conditioner will be started when it is energized or will be stopped when it is in operation.
4		• Everytime you press this button, the operation mode is changed in sequence: COOLING → FAN ONLY → HEATING → COOLING
5		• Used to select fan speed in sequence auto, high, mid and low.
6	 	<ul style="list-style-type: none"> • This button Used to set room temperature mode or used to set time in TIMER mode. If the two keys are pressed at the same time last more than three seconds, the temperature LED display will alternate between °C and °F. NOTE: Temperature setting range is from 61°F (16°C) To 88°F (31°C).
7		• To activate the function “SLEEP”

Indication symbols of LED on control panel

No.	Button	Function
1		Timer
2		Cooling
3		Heating
4		Fan only
5		Sleep
6		Display set temp./Display set timer
7		Low fan speed
8		Mid fan speed
9		High fan speed
10		Auto fan speed
11		Compressor running

Above LED lights on when the relevant mode is in used.

Operating Instructions

Remote controller

The remote controller transmits signals to the system.

No.	Button	Function
1	▲ (TEMP UP)	Increase the temperature or time by 1 unit
2	▼ (TEMP DN)	Decrease the temperature or time by 1 unit
3	ON/OFF	To switch the conditioner on and off.
4	FAN	To select the fan speed of auto/low/mid/high
5	TIMER	To set automatic switching-on/off
6	SLEEP	To activate the function "SLEEP"
8	MODE	To select the mode of operation
9	SWING	To activate or deactivate of the movement of the "DEFLECTORS".

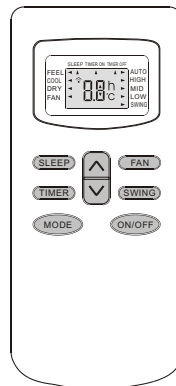

Remote Controller

⚠ The outlook and some function of remote control may vary according to the model.

⚠ The shape and position of buttons and indicators may vary according to the model, but their function is the same.

⚠ The unit confirms the correct reception of each press button with a beep.

Electrical specifications

1. All wiring must comply with local and national electrical codes and must be installed by a qualified electrician. If you have any questions regarding the following instructions, contact a qualified electrician.
2. Check available power supply and resolve any wiring problems BEFORE installing and operating this unit.
3. For your safety and protection. This unit is grounded through the power cord when plugged into a matching wall outlet. If you are not sure whether your wall outlet is properly grounded, please consult a qualified electrician.
4. The rating plate on the unit contains electrical and other technical data. The rating plate is located on the right side of the unit. Make sure to use correct power supply according to the rating plate of your air conditioner.
5. The wiring diagram is as below.

⚡ Electric Shock Hazard ⚠

The air conditioner has a serial rating volts. It must have its own fuse or circuit breaker, and no other device or unit should be operated on the fuse or circuit breaker.

To avoid the possibility of personal injury, disconnect power to the unit before installing or servicing.

DCB05C/DCB07C/DCB09C

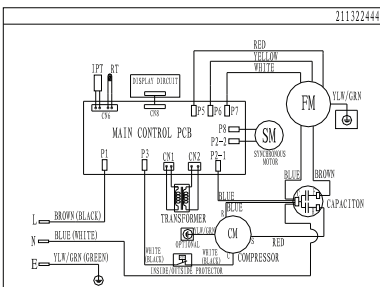

RECEPTACLE AND FUSE TYPES

	DCB05C	DCB07C	DCB09C
RATED VOLTS	250V	250V	250V
AMPS	7.1A	7.1A	7.1A

RECEPTACLE AND FUSE TYPES

	DCB07	DCB09	DCB14
RATED VOLTS	250V	250V	250V
AMPS	7.1A	7.1A	8.5A

DCB07/DCB09

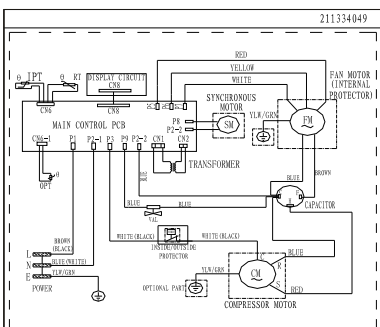

DCB14

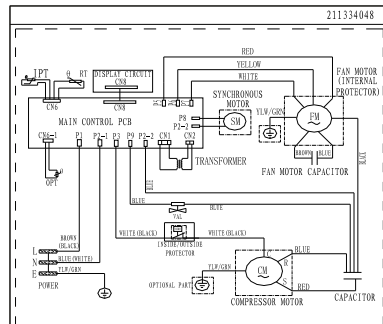

Installation instructions

REMOVE ALL THE SHIPPING PARTS BEFORE INSTALLATION

LOCATION

- Select a location that can support the weight of the air conditioner and one that will not cause increased operation noise and vibration.
- Direct sunlight is unfavorable for efficient cooling.
- Select a place where there is no obstacles near the air inlet and outlet.

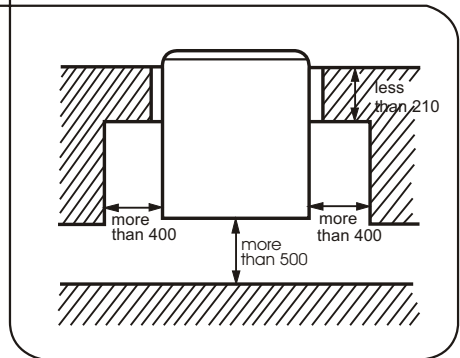
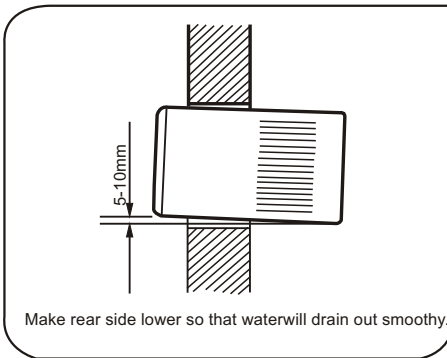
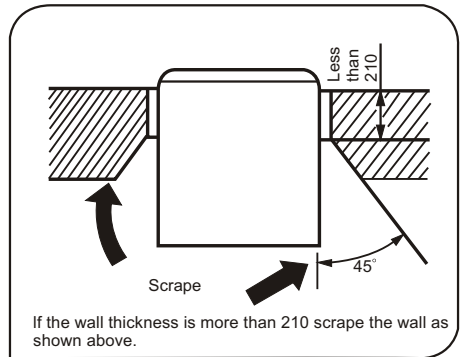
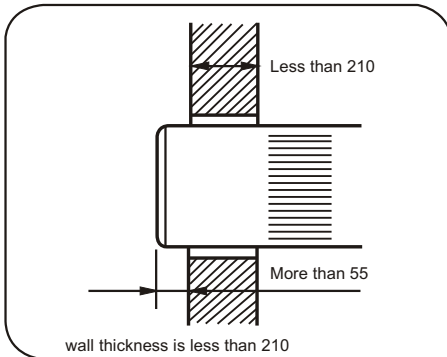

Installation instructions

CAUTION

- Do not install air conditioner in the place where flammable gas leaks are a possibility.
- The minimum clearance from the appliance to combustible surfaces is 100mm; (Only for electric heating)
- The range of external static pressures at which the appliance was tested is 0-5Pa

OPERATION

- Check the capacity of wiring and power outlet. The power outlet should be used exclusively for the air conditioner. Do not use it with other appliances.
- Ground the air conditioner to prevent danger of electric shock.
- Connect the air conditioner with power source securely.
- Use a fuse as below.

CAUTION

- Before installation, turn off the operation switch and disconnect the power cord.
- This appliance is not intended for use by persons (including children) with reduced physical, sensory or mental capabilities, or lack of experience and knowledge, unless they have been given supervision or instruction concerning use of the appliance by a person responsible for their safety. Children should be supervised to ensure that they do not play with the appliance.
- The appliance is fitted with means for disconnection from the supply mains having a contact separation in all poles that provide full disconnection under over voltage category III conditions, and these means must be incorporated in the fixed wiring in accordance with the wiring rules.

Installation instructions

- 1) Remove the front panel. (Fig.5)
 Remove the air filter. (Fig.6)
 Remove screw at the bottom of the front panel. (Fig.7)
 Open the panel cover.
- 2) Remove the screws fix the chassis-fixing board and cabinet.
 some Models have two more screws on the back of the cabinet. (Fig.8)
- 3) Grasp the handle on the front of the chassis and carefully slide the air conditioner unit out of the cabinet. (Fig.9)
- 4) Install the drain tube connection into the hole provided at the rear of the air conditioner chassis.(Fig.11)
 To meet different requirements of different type of air conditioner, there are two kinds of methods for your choice to treat the condensed water. You can choose back drainage or bottom drainage.
 Bottom drainage way: the drain tray is fixed in position through four pcs of screws and use the flare nut to block the back drainage hole.(Fig.15)
 Back drainage way using the flare nut to block the bottom drainage hole and use water outlet pipe to connect the back drainage hole pay attention to increase the sealing ring to prevent water leakage.(Fig.16)
- 5) Install the air conditioner cabinet on the installation shelf (not included) with screws.(Fig.10)
- 6) Carefully slide the unit back into the cabinet.(Fig.12)
- 7) Reinstall the retaining bracket, front panel and mounting screws.(Fig.8,7,13)
- 8) Reinstall the air filter.(Fig.14)

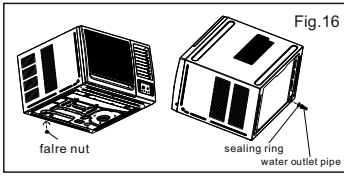
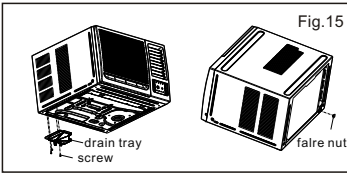
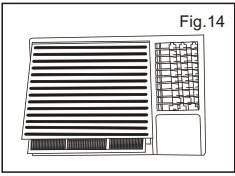
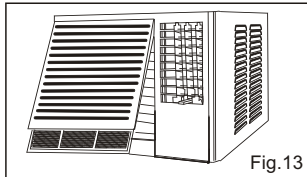
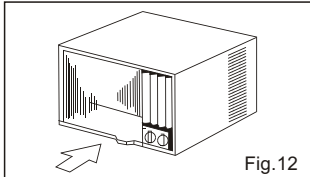
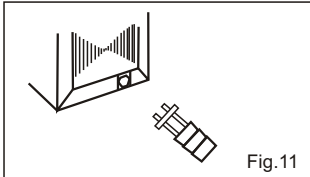
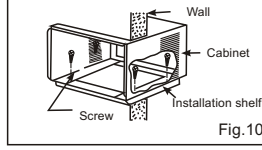
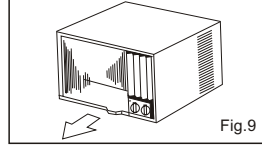
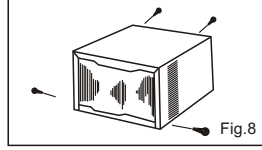
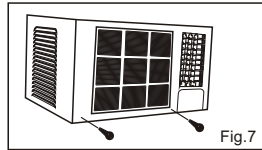
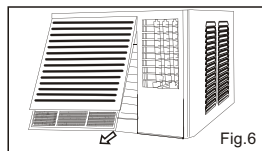
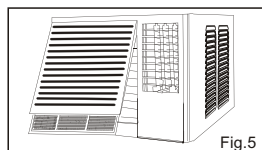

Care and Maintenance

AIR FILTER

- The air filter should be washed at least once a month. If the air filter remains full of dust, the air flow will decrease and the cooling capacity will be reduced.
- The filter is behind the cover and to be pulled out from right hand side.
- Wash the air filter with water and detergent.
- Rinse with clean water and dry completely before reinstalling.

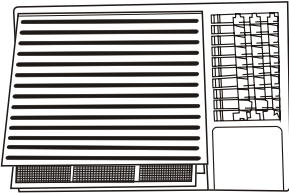

Fig.15

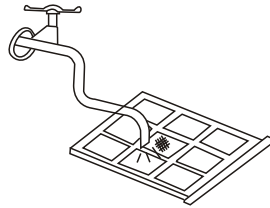

Fig.16

CAUTION

- Do not use hot water above 40°C for washing the air filter.
- Let the filter dry thoroughly in the shade before reinstalling. Do not expose it directly on the sun.
- Do not operate the air conditioner with the filter removed.
- T1 condition: The ambient temperature for cooling: 18~43°C;
The ambient temperature for heating: -5~20°C.
- T3 condition: The ambient temperature for cooling: 25~52°C;
The ambient temperature for heating: -5~20°C.

AIR CLEANING FILTER

- The air cleaning filter is attached to the air filter. Wash the air cleaning filter as well when wash air filter.

FRONT COVER, ETC

- The front cover will accumulate dirt and dust. To clean it, wipe it with a soft dry cloth. When it is excessively dirty, wipe it with a soft cloth dampened with warm water or mild soap, then wipe it again thoroughly with a soft dry cloth.

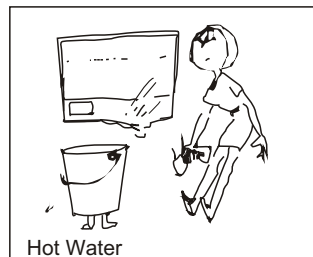

Troubleshooting Guide

- Never use hot water above 50°C, benzene, gasoline, acid, thinner or brush to wipe off dirt because they will damage the plastic surface and the coating.

LONG OFF PERIOD MAINTENANCE

- Operate the fan alone ("LOW FAN" or "HIGH FAN") for half a day to dry out the inside of the unit.
- Turn off power and remove plug from wall socket.
- After a long off period and going to use the air conditioner again, clean the CONDENSER (at the rear) and EVAPORATOR (at the front) fins by using a soft brush or vacuum cleaner.

CAUTION

- Be careful not to damage the fins during the cleaning.

BEFORE ASKING FOR SERVICE

Check the following points before requesting for repairs or service. If the malfunction persists, please contact our customer service.

Faults	Cause
Does not operate	<ul style="list-style-type: none">① Is the power off?② Is the fuse blown?③ Is the voltage extremely high or low?④ Is the operation dial set to "off"?
Does not cool effectively	<ul style="list-style-type: none">① Is the air filter remain full of dust or dirt? See air filter instructions on page 9.② Is the sunlight fall directly on the unit?③ Is the air flow on the rear side obstructed? Leave a space of 500mm behind the rear side of the air condition?④ The doors or windows may be opened widely or there are other sources of heat in the room?⑤ The temperature dial may not set to the colder position. Turn the dial further clockwise.⑥ Is the ventilation damper opened?

CONTACT DETAILS

Glen Dimplex Australia Pty Ltd
1340 Ferntree Gully Road
Scoresby VIC 3179
Australia

Ph: 1300 556 816
Web: www.dimplex.com.au

Glen Dimplex New Zealand Ltd
38 Harris Road
East Tamaki, Auckland
New Zealand

Ph: 09 274 8265
Web: www.dimplex.co.nz