

HCS-3300/3302/3304 USB

Remote Programmable Laboratory Grade Switching Mode Power Supply

User Manual

1. INTRODUCTION

This family of efficient, upgraded SMPS with small form factor, auto cross over CV CC, 3 VI presets, remote control offers unique solution for various loading conditions and applications.

The dual action (coarse/fine tune) rotary encoder tuning with MCU makes setting the voltage and current levels ever so smooth, precise and fast. Setting, changing, and checking the current limit level can be done easily without sparking the output poles.

The analogue remote control functionality allows the output power on/off, voltage & current be adjusted without touching the front panel of the power supply.

The USB port is added for access to computer to run cyclical operation with Max. 20 programmable sets of preset of voltage and current with different time duration and up to 999 cycles.

It is suitable for a wide range of applications such as laboratory, telecommunication, production testing, field test of voltage critical distant load, powering of dc network and etc...

The 3 user defined presets facilitate quick access to frequently used VI settings.

2. WARNING

- Do not use this power supply near water.
- Do not operate or touch this power supply with wet hands.
- Do not open the casing of the power supply when it is connected to ac mains.
- Refer all servicing to qualified service personnel only.
- Before replacing the AC fuse at AC socket, find out and clear up the cause first.
- Replace the AC fuse with the same type and rating as the original fuse.
- The max. output voltage of Model HCS-3304 is over 60VDC, avoid touch the metal contact part of the output terminals.
- This power supply is designed for using in non-cascade environment. It is not recommended to connect two or more power supplies in parallel or in series.
- Analogue Remote Control or Remote Programming via USB function is only suitable for stand-alone one unit operation.
- Do not use this power supply with electrical motors, solenoid or inductive load that generates a back EMF and voltage transient which may damage the power supply

3. CAUTION

- Use a grounded 3 pin AC source.
- This unit is for indoor use only.
- Do not operate or place this unit in a humid, dusty, in direct sunlight location or near any heat source.
- Before plugging into local AC mains, check with the rating label at the back of the unit.
- Do not block any ventilation openings of the unit.
- This unit must be used within the specified rating, regular excessive continuous loading may cause damage to the power supply.
- The gauge size of input power cable must be at least 0.75mm² and the total length of power cable must not exceed 3m.

4. OPERATION ENVIRONMENTAL CONDITION

- 10-80% R.H.
- Altitude up to 2000m
- Installation category: CAT 2
- Pollution degree: 2
- Mains supply voltage fluctuation up to ±10% of the normal voltage

5. CONTROLS AND INDICATORS

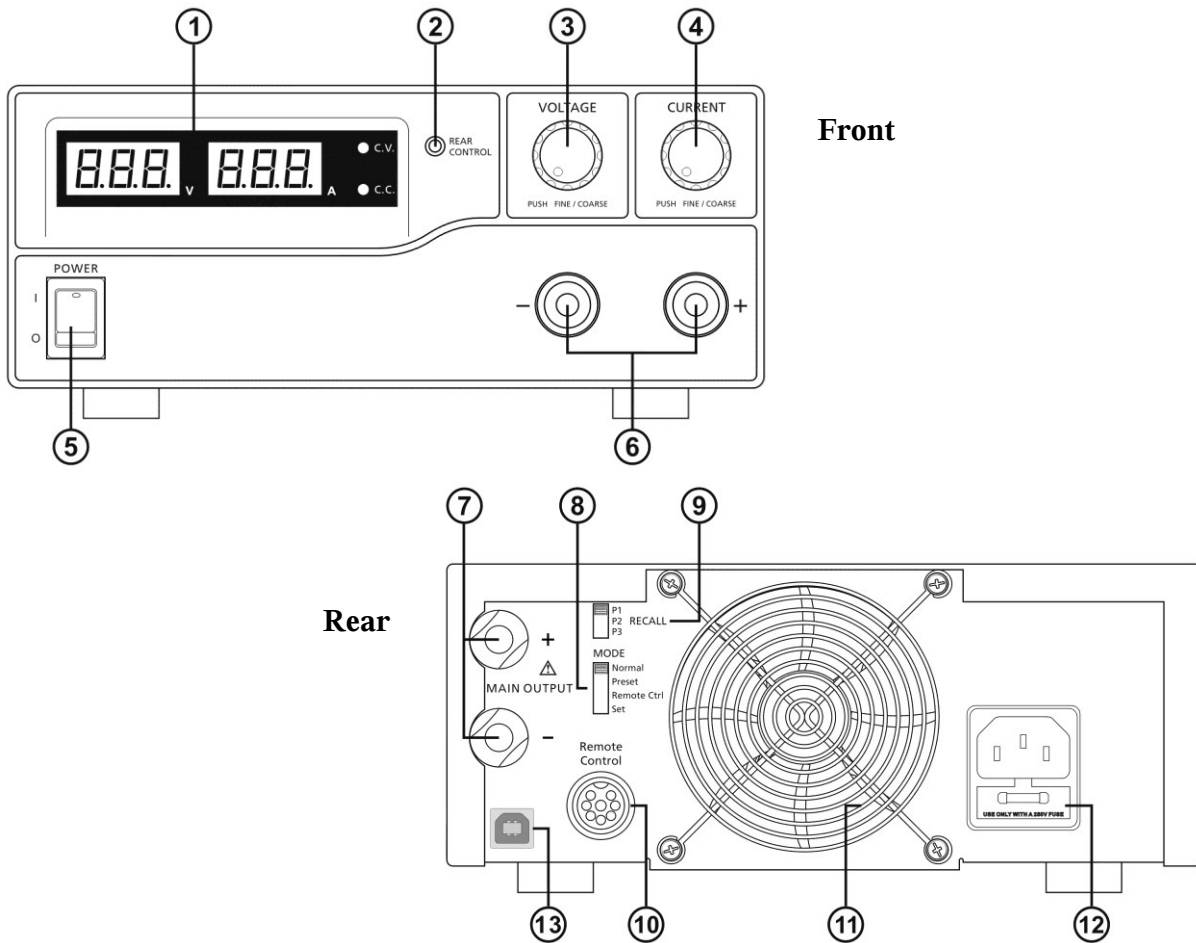

- (1) LED panel meter display with CC/CV Indicator
- (2) Rear Control Indicator (**lights up when using Preset/ Remote Control/ Set mode**)
- (3) Output Voltage Control Knob (**control both the main and auxiliary output voltage**)
- (4) Output Current Control Knob (**control both the main and auxiliary output current limit**)
- (5) Power ON/OFF Switch
- (6) Aux. output terminal (max 5A)
Note: HCS-3300: The total rated current (Aux.+Main) is 30A
HCS-3302: The total rated current (Aux.+Main) is 15A
HCS-3304: The total rated current (Aux.+Main) is 8A
- (7) Output Terminal (**Rated 30A for HCS-3300/ Rated 15A for HCS-3302/ Rated 8A for HCS-3304**)
- (8) Mode Selection Switch (**Normal, Preset, Remote Control, Set Modes**)
- (9) Recall Selection Switch
- (10) Remote Control Terminal
- (11) Cooling Fan Air Intake Grille
- (12) AC Input Plug
- (13) USB port
 (for access to computer to run cyclical operation with programmable voltage, current, period time and cycle)

6. CONTROL MODE SELECTION

There are 4 modes, Normal, Preset, Set and Remote Control mode for the power supply.

Slide the Mode Selection Switch (8) to your desired Mode.

The power supply is factory preset to Normal Mode with maximum current level CC.

6.1 Normal Mode

This is the factory preset mode and the power supply output V, I, are controlled by the dual action volume knobs.

Push the knobs to toggle the coarse and fine tuning, notice the subtle changes in brightness of related LED.

Adjust the knobs to your desired values by trying coarse and fine tuning.

To check the preset current level, just turn the Current Knob lightly in any direction.

The display will resume its normal brightness after few seconds to double confirm your adjustment.

6.2 Preset Mode

a. In this mode, the Rear Control Light is on to indicate panel V & I controls are de-activated.

b. There are 3 preset output P1/ P2/ P3 at the Recall Selection Switch (9)

c. The preset values are factory set as following table.

d. End user can set his own output rating, please refer to paragraph 6.3

Recall No.	Output Voltage	Output Current
P1	5V	Maximum
P2	13.8V	Maximum
P3	HCS-3300: 15V HCS-3302: 25V HCS-3304: 55V	Maximum

6.3 Set Mode – First enter into the Set Mode by pushing Switch (8) to Set Mode slot.

The power supply is then ready to be preset.

6.3.1 To define the preset output P1/ P2/ P3.

a. Select the Recall Switch (9) to the position P1, P2 or P3 which you want to set

b. Adjust the front panel voltage control knob to set your desired voltage value

c. Adjust the front panel current control knob to set your desired current limit value

d. Repeat the procedure for remaining recalls P1, P2, P3 if desired.

e. Move Mode Switch (8) from Set to Preset position to confirm your settings.

Remarks:

All the set values in the presets will be kept even after the power supply has been tuned off.

Always check output voltage of Presets before connect to Load

To check the preset values, move Mode Switch (8) to Preset position

Move the Recall Switch (9) to P1, P2 or P3.

The V and I settings of corresponding RECALL P1, P2, P3 will be show on the panel meters.

6.3.2 To reset the unit back to factory setting

a. Turn OFF the power supply

b. Push and hold both front panel voltage and current control knobs at the same time

c. Turn ON the power supply again

d. Release front panel voltage and current control knobs

6.4 Analogue Remote Control Mode

To control the output voltage and current by remote control connector (10)

Please refer to paragraph 8

7. Using the power supply

- 7.1 This series has 3 models. Make sure you have used the correct one. They have different output voltage range and current as following:











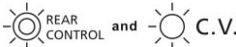

Model Number	Output Voltage Range	Total Rated Current
HCS-3300	1 ~ 16V	0 ~ 30A
HCS-3302	1 ~ 32V	0 ~ 15A
HCS-3304	1 ~ 60V	0 ~ 8A

- 7.2 Check the rating label of the power supply and make sure it complies with your AC mains voltage. Connect the power supply to the AC Mains using the provided power cord.

Make sure the Mode Switch (8) is at Normal Position.

- 7.3 The power supply will perform a series of self checks when it is switched on. The LED and other indicators on the front panel will be on by turn. When the cooling fan is being checked, a high speed wind noise can be heard. After the self checks, the CV, V and A LED indicators are lit up displaying voltage and 0.0 current. To find out about the set CC current level, just turn the current control knob one click in either direction. The current display returns to 0.0 after a few seconds.

Below table to show the self test sequence

Self test display and Sequence	Test contents
	To show software version
	Segment check
	C.V. Indicator check
	C.C. Indicator check
	Rear control indicator check
	Return to C.V.
	Start to check
	Over voltage protection check
	Over load protection check
	Over temperature protection check
	Fan check
	Output off (remote control mode)

7.4 Using the control knobs

The rotary encoder control knobs have fine and coarse tuning with clicking movement.

Push the knobs to toggle between coarse and fine tuning, notice the subtle changes in brightness of related LED. .

Adjust the knobs to your desired values by trying coarse and fine tuning.

The display will resume its normal brightness after few seconds to confirm your adjustment.

7.5 Connect the equipment to the power supply. Red (+) is connected to the positive polarity input of the equipment and Black (-) is connected to the negative polarity input of the equipment.

7.6 Switch on the power supply first and the panel meter & green CV Indicator should light up again.

7.7 Switch on the equipment and the panel meter & green CV Indicator should still remain in green.

7.8 You can now operate the equipment.

When an operation is finished, switch off the equipment first and then switch off the power supply.

8. ANALOGUE REMOTE CONTROL MODE

There are two methods for remote control of current and voltage adjustment.

Both methods require both the current remote control part and the voltage remote control part to be set up and be in used at the same time in order for analogue remote control mode to be functional.

Otherwise unit will be in CC mode all the time and the analogue remote control will not be functional.

8.1 **Method A** Using two external variable DC voltage sources

Remote Socket Pin Assignment for external variable voltage source PIN FUNCTIONS

Remote Socket Pin Assignment for external variable voltage source		
PIN	FUNCTIONS	REMARKS
1	Internal DC +5V	Less then 50mA
2	Voltage Adjust	0 - 5V
3	Current Adjust	0 - 5V
4	Ground	
5	Output OFF	Short to Ground
6	N.A.	
7	N.A.	
8	N.A.	

CC current setting by remote control.

Short circuit the main output with 12AWG wire.

Adjust the CC current using external power supply connected to Pin 3.

Output voltage setting by remote control

Check the output voltage range of the power supply by varying the external voltage source connected to Pin 2.

8.2 Method B Using two 0 – 5K Ohm variable resistors

Two variable resistors must be set up at the same time in order for the remote control to be functional.

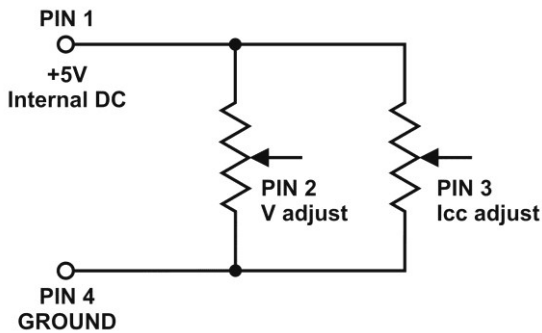

Remark: variable resistors 5Kohm.

Remote Socket Pin Assignment for variable resistor		
PIN	FUNCTIONS	REMARKS
1	Internal DC +5V	Resistor end
2	Voltage Adjust	Variable part of resistor
3	Current Adjust	Variable part of resistor
4	Ground	Another resistor end
5	Output OFF	Short to Ground
6	N.A.	
7	N.A.	
8	N.A.	

CC current setting by remote control.

Short circuit the main output with 12AWG wire.

Adjust the CC current setting using the 0-5k Ohm variable resistor.

Output voltage setting by remote control

Check the output voltage range of the power supply by adjusting the 5Kohm variable resistor.

8.3 Remote Output ON/OFF Control

This remote output on/off control can be activated in any of the modes Normal, Preset, Remote and Set mode.

- By default, Pin 5 is open and output is on.
- Shorting Pin 5 to Pin 4 (ground) and output is off.
- When output is off, the C.V. & C.C. LED will flash. The current output voltage and current setting will show on the panel meter.
- You also can adjust the output by voltage & current control knob to your desired value when output is off.

Remark: using the 8pin remote plug provided and connect with 22AWG wires.

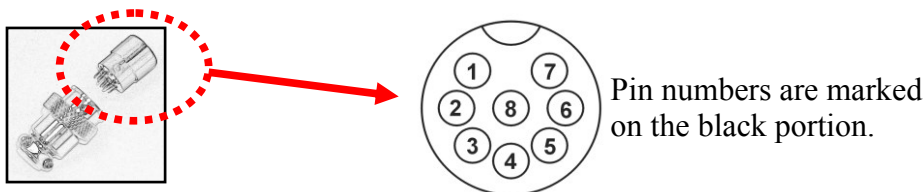

CAUTION !

The allowable fastest switching On/Off frequency is two times per second.

When the On/Off frequency is over two per second, the power supply may not work normally and protections may be triggered.

9. FAULTS AND TROUBLE SHOOTING

9.1 OUP: Over Voltage Protection

This unit has a built-in tracking over voltage protection feature. In the event of output voltage becoming greater than the set value (see specified range from specifications table), protection will be triggered and the output power will be cut off and OUP warning appears as below.



To reset the warning, switch off the unit and remove all loading.
Switch the unit back on again and it should resume normal operation.
If this problem persists, please contact and consult with your agent.

9.2 OTP: Over Temperature Protection

There is a thermo sensor inside the unit to monitor and to prevent the unit to gets too hot inside. At OTP, there is no output and the following warning will appear on the LED display.
When you get this warning, switch off the unit and remove all loading.



Check your load and output setting. Allow the unit to cool down for at least 30 minutes.
Check if any of the ventilation is blocked, check enough clearance around power supply.
Listen carefully for the short wind noise from the cooling fan when you turn on the unit again.
If you cannot hear this routine self test wind noise on switch on, the fan is fault and do not use the power supply, contact your agent.

9.3 OLP: Over Load Protection

Normally the overload protection is sustained by the CC constant current mode.
When the CC mode fails and goes undetected, it may cause serious damage to your test piece or load.
The OLP is to minimize the extent of damage to your loads as power supplies do fail someday.
Switch off your power supply as soon as you see this warning as shown below.



To reset this warning, switch off the unit and remove all loading.
Switch the unit back on again and double check with caution.
If this problem cannot be fixed, please contact and consult with your agent.

10. SPECIFICATIONS

Models	HCS-3300	HCS-3302	HCS-3304
Output			
Variable Output Voltage	1 - 16VDC	1 - 32VDC	1 - 60VDC
Variable Output Current	0 - 30A	0 - 15A	0 - 8A
Voltage Regulation			
Load (10-100% Load)	50mV		
Line (170-264VAC Variation)	20mV		
Current Regulation			
Load (10-90% Rated Voltage)	150mA	100mA	100mA
Line (170-264VAC Variation)	50mA		
Ripple & Noise			
Ripple & Noise (r.m.s.) Voltage	5mV		
Ripple & Noise (peak-peak) Voltage	50mV	50mV	100mV
Current Ripple & Noise (r.m.s.)	50mA	20mA	10mA
Meter Type & Accuracy			
Voltage Meter	3 Digit LED Display $\pm 0.2\%$ +3 counts		
Current Meter	3 Digit LED Display $\pm 0.2\%$ +3 counts		
Other			
Input Voltage	200 – 240VAC 50/60Hz~ (or on request)		
Full Load Input Current	2.5A		
Efficiency	85%	86%	88%
Switching Frequency	65 – 85Khz~	75 – 95Khz~	65 – 85Khz~
Tracking Over Voltage Protections	O/P 1-5V: set voltage +2V O/P 5-15V: set voltage +3V	O/P 1-5V: set voltage +2V O/P 5-20V: set voltage +3V O/P 20-30V: set voltage +4V	O/P 1-5V: set voltage +2V O/P 5-20V: set voltage +3V O/P 20-60V: set voltage +4V
Transient Response Time (50-100%Load)	1.5ms		
Power Factor Control	Power factor correction >0.95 at optimal load		
Cooling Method	Thermostatic Control Fan from Zero to full speed		
Protections	Overload, Short Circuit by Constant Current, Output Tracking Over Voltage, Over Temperature		
Special Features	3 User defined VI preset, Remote control V, I and output on-off		
Preset Cycle Programming	Max. 20 presets of V & I Max. preset time 99min. + 59sec. Max. preset cycle 999		
Accessories	User Manual, Application Software, USB cable		
Approvals	CE EMC: EN 55011, 55022 LVD: EN 60950, 61010		
Dimensions (WxHxD)	200 x 90 x 215 mm 7.9 x 3.5 x 8.5 inch		
Weight	2.6 kg 5.7 lb		

11. PC Interface Control

Support OS: Windows XP/Vista/7 (32bits/64bits)

Driver: Silicon Lab CP210x USB driver

(Included in CDROM folder “USB CP210x Drivers V6.5 for Win_XP_S2K3_Vista_7”)

Execute Program: run “<CDROM Drive>:\hcs\hcs.bat”

A. Main Display

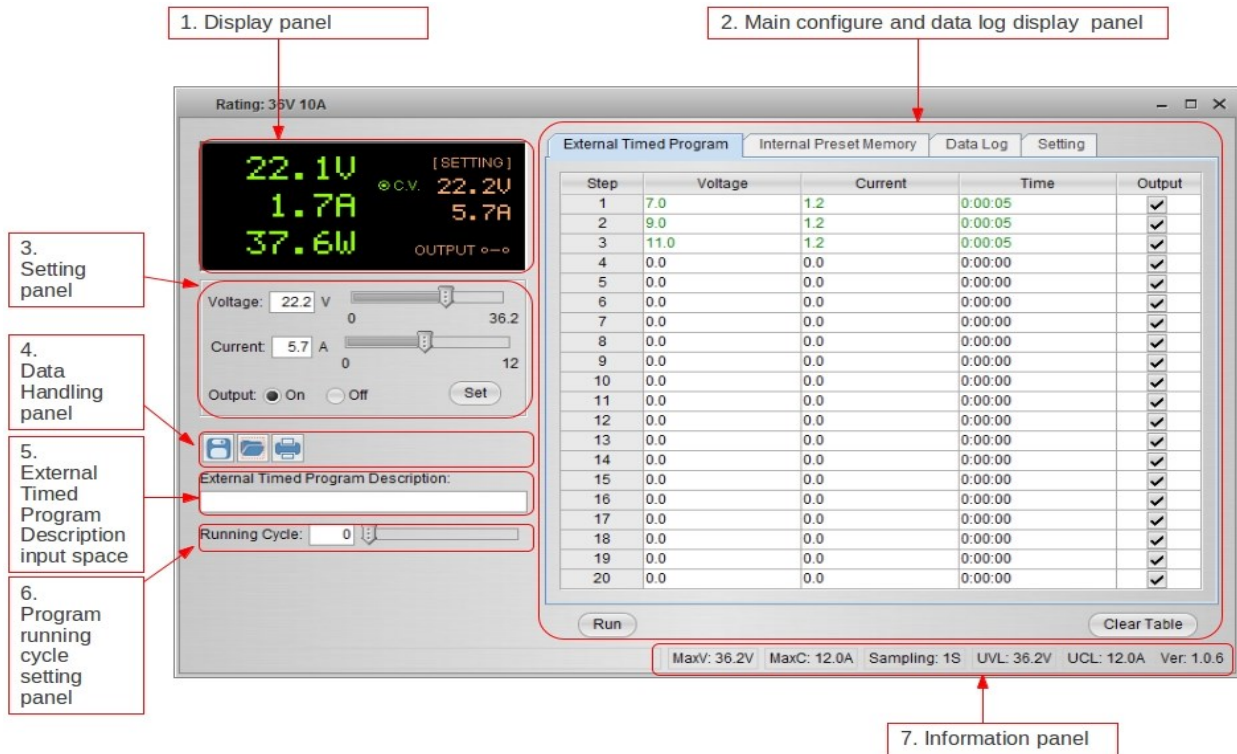

The Main interface divided into 7 panels.

1. Display panel – use to display real-time information of power supply.
2. Main configuration and data log display panel – use to change general setting of program and display data log.
3. Voltage and Current setting panel – use to set incident output value and output On/Off.
4. Data handling panel – use to save, load and print data.
5. External Timed Program Description input space – use to enter description of External Timed Program.
6. Program running cycle setting panel – use to set running cycle for External Timed Program.
7. Information panel – use to display Maximum voltage/ current, Sampling time, upper voltage/ current limit and software version.

B. Display panel

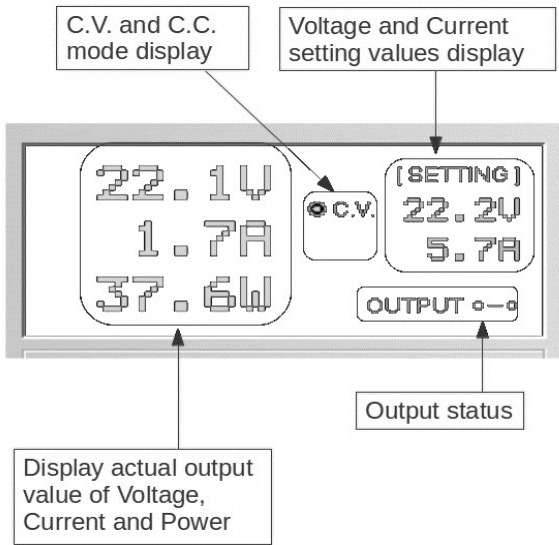

The display show following information

- Output Voltage value
- Output Current value
- Output Power value
- Output On/Off status
- C.V./ C.C. Model
- Setting values

C. Set output value and On/Off status

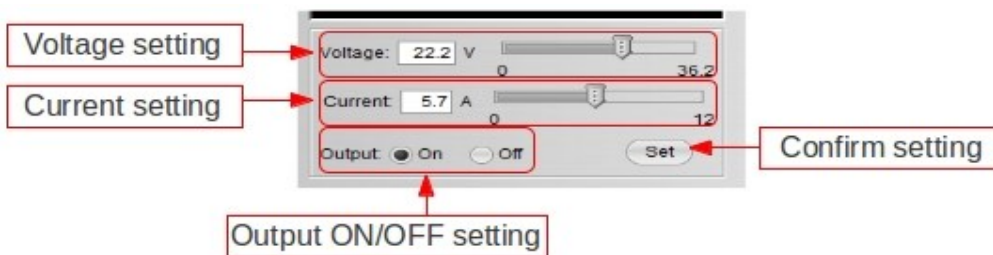

You can directly type the desired output voltage & output current and then click “Set” button to set the value. Or you can use slide bar to adjust the value.

D. External Timed Program

Step	Voltage	Current	Time	Output
1	0.0	0.00	0:00:00	<input checked="" type="checkbox"/>
2	0.0	0.00	0:00:00	<input checked="" type="checkbox"/>
3	0.0	0.00	0:00:00	<input checked="" type="checkbox"/>
4	0.0	0.00	0:00:00	<input checked="" type="checkbox"/>
5	0.0	0.00	0:00:00	<input checked="" type="checkbox"/>
6	0.0	0.00	0:00:00	<input checked="" type="checkbox"/>
7	0.0	0.00	0:00:00	<input checked="" type="checkbox"/>
8	0.0	0.00	0:00:00	<input checked="" type="checkbox"/>
9	0.0	0.00	0:00:00	<input checked="" type="checkbox"/>
10	0.0	0.00	0:00:00	<input checked="" type="checkbox"/>
11	0.0	0.00	0:00:00	<input checked="" type="checkbox"/>
12	0.0	0.00	0:00:00	<input checked="" type="checkbox"/>
13	0.0	0.00	0:00:00	<input checked="" type="checkbox"/>
14	0.0	0.00	0:00:00	<input checked="" type="checkbox"/>
15	0.0	0.00	0:00:00	<input checked="" type="checkbox"/>
16	0.0	0.00	0:00:00	<input checked="" type="checkbox"/>
17	0.0	0.00	0:00:00	<input checked="" type="checkbox"/>
18	0.0	0.00	0:00:00	<input checked="" type="checkbox"/>
19	0.0	0.00	0:00:00	<input checked="" type="checkbox"/>
20	0.0	0.00	0:00:00	<input checked="" type="checkbox"/>

Run Clear Table

External Timed Program is completely controlled by PC, PC counts the time and changes voltage and current of power supply.

Select External Timed Program tab to switch to the External Timed Program tab.

- Double click on the cell that you would like to set value. For example Step 2 voltage.
- Slide the bar to configure the value.



Step	Voltage	Current	Time	Output
1	10.0	1.00	0:00:15	<input checked="" type="checkbox"/>
2	20.0 	0.00	0:00:00	<input checked="" type="checkbox"/>
3	0.0	0.00	0:00:00	<input checked="" type="checkbox"/>

- Set time for this step to be running. The time range is between 0 to 9hours 59 minutes 59 seconds. You can click up/down button to change value or directly input value. If the time value is set to 0, this step will be skipped.

ent	Time	Out
	0:00:05	<input checked="" type="checkbox"/>
	9:59:59 	<input checked="" type="checkbox"/>
	0:00:03	<input checked="" type="checkbox"/>
	0:00:00	<input type="checkbox"/>

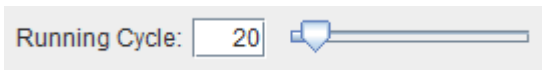
- Select running cycle between 0-999. You can use slide bar to select or directly input value in text box. Input 0 means run the program forever.

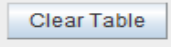

- Click on  button to start running cycle.
- In between program running cycle, click  button to stop program.
- Click  to clear the setting.

E. Internal Preset Memory

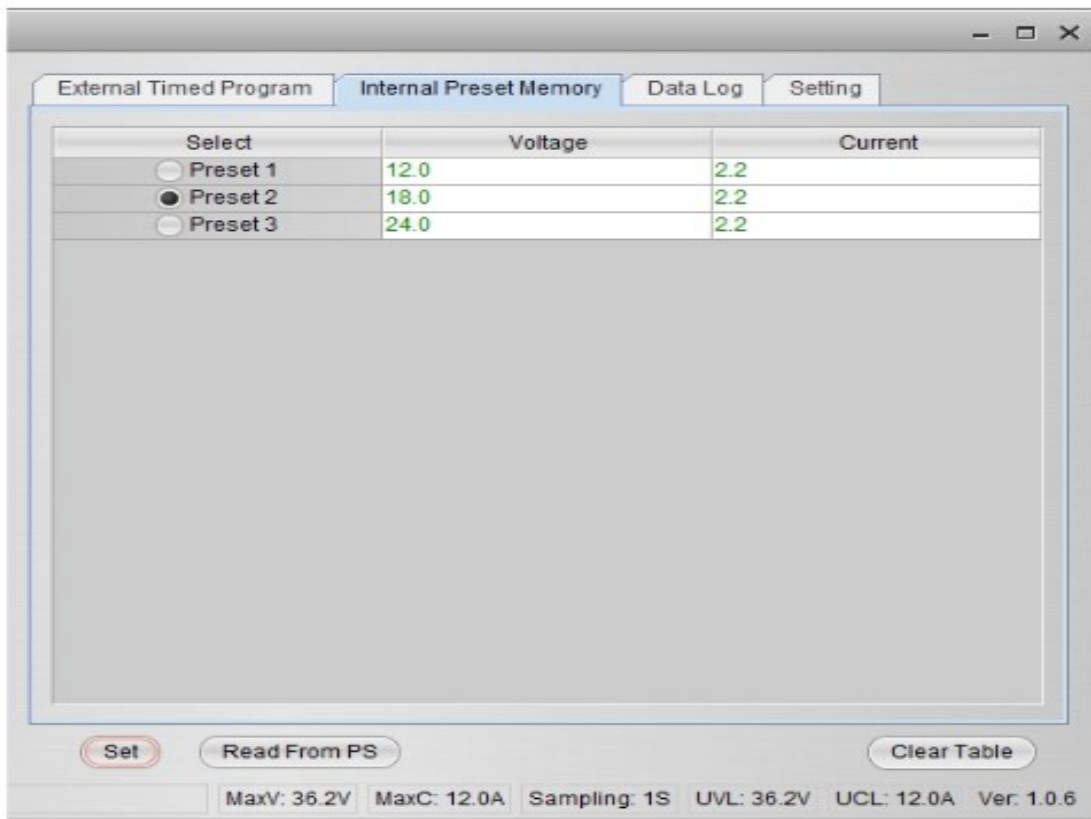

The PC interface remote mode really eliminates the tedious process in keying in groups of entries on the power supply. Because all the data are displayed together in the monitor, possibility of wrong entry is greatly reduced. Data of different groups can be classified, stored, exported and retrieved for use at any time. Furthermore, retrieved data will be in red color if they exceed the present preset limits of voltage in upper voltage level or current limiting value.

- Clear Table ----- Delete all data on the Display Table to ready for new data entry.
- Read for PS ----- Get data from the Power Supply.

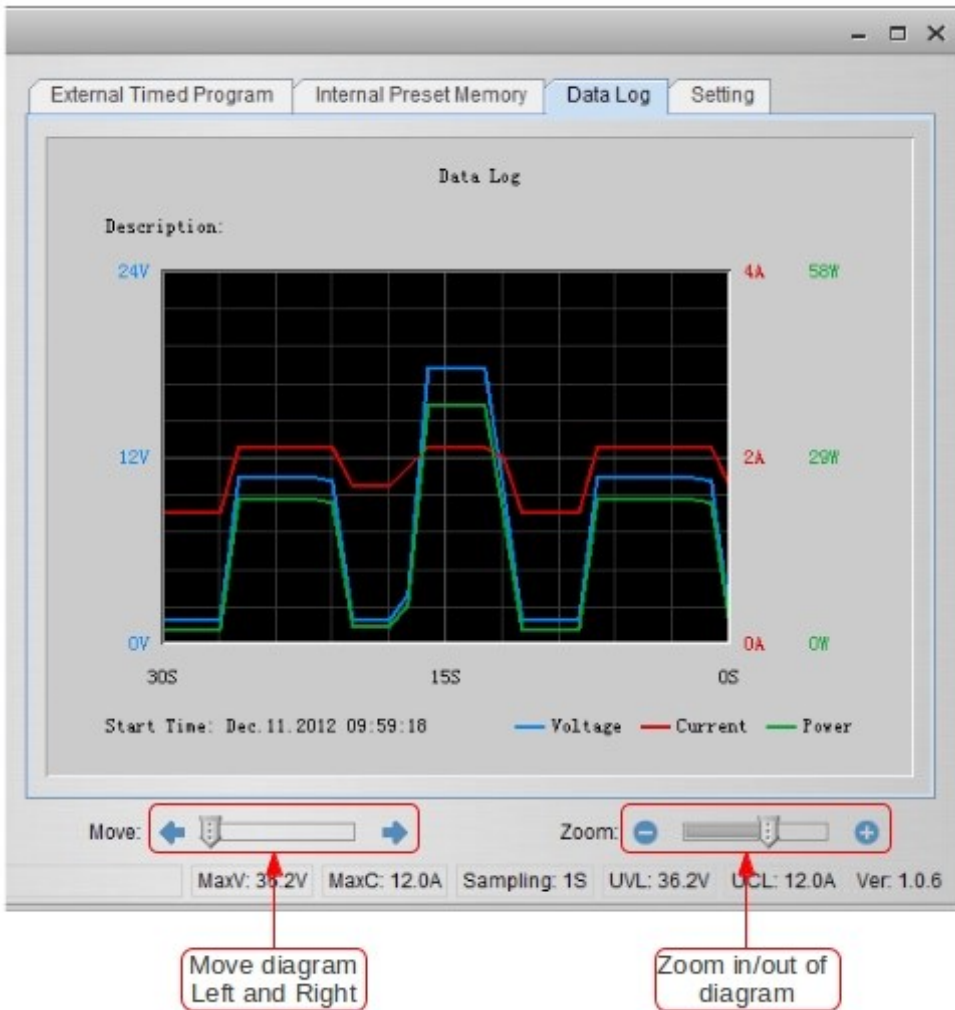

F. Data Log

Data Log window



Data log window is used to display output Voltage, Current and Power against time in graphical view. You can move the diagram left and right by adjust “Move:” slide bar. You can zoom in/out the diagram by adjust “Zoom:” slide bar.

You can save the data in CSV file for analysis later.

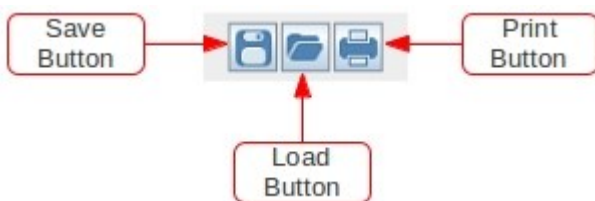

- Click  to save Data log to CSV file.
- Click  to open and load data from CSV file to program for analysis.
- Click  to print the setting to print.

G. Save, Load and print setting





In previous session, the above 3 buttons are used to save, load and print log data. In addition, these buttons can be used to save, load and print setting for External Timed Program and Internal Preset Memory. First, select tab in Main configure and data log display panel.

When “External Timed Program” tab is being selected, the buttons are used to save and load the setting of External Timed Program.

- Click  to save External Timed Program setting to CSV file.
- Click  to open and load setting from CSV file to program.
- Click  to print the setting to print.
- If you want to add description for your setting. Input the description in following “External Timed Program Description:” space to before save.

External Timed Program Description:

When “Internal Preset Memory” tab is being selected, the buttons are used to save and load the setting of Internal Preset Memory.

- Click  to save Internal Preset Memory setting to CSV file.
- Click  to open and load setting from CSV file to program.
- Click  to print the setting to print

H. Setting

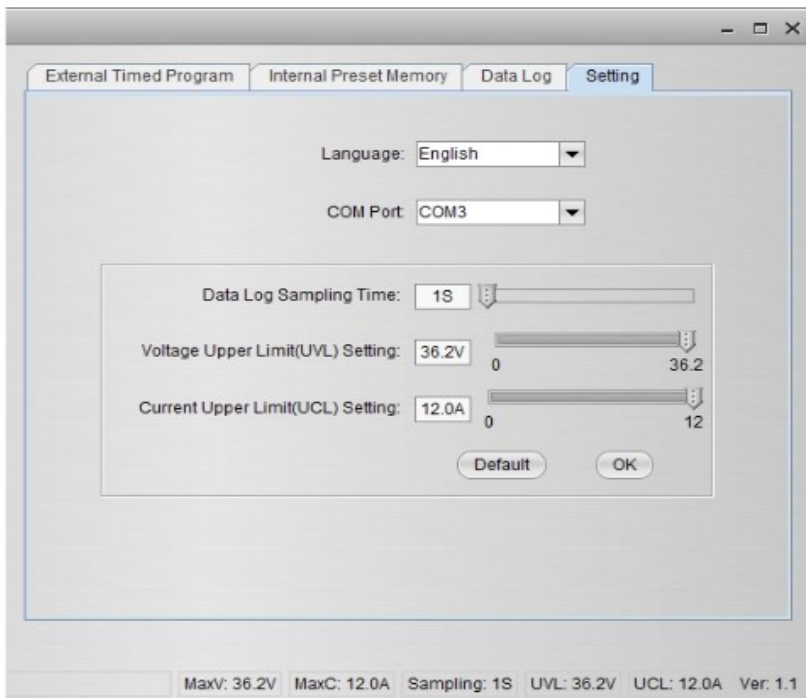

In the setting page, you can do general setting for the program.

You can select language for the program

You can select the COM Port for power supply connected

You can set sampling time for data log by adjust slide bar

You can set your output voltage upper limit (UVL) value to further safeguard your low voltage applications.

You can set your output current upper limit (UCL) value to further safeguard your low current applications.

I. Command Set

Command line format

COMMAND<parameter1><parameter2>... [CR]

Remark:

One decimal place for current value: HCS-3100, 3150, 3200, 3202, 33XX, 34XX, 36XX

Two decimal places for current value: HCS-3102, 3014, 3204

Command code & return value	Function	Example
Input Command: GMAX [CR] Return value: <voltage><current>[CR] OK[CR]	Get PS maximum Voltage & Current value <voltage>=??? <current>=???	Input command: GMAX [CR] Return value: 180200[CR] OK[CR] Meaning: Maximum Voltage is 18.0V Maximum Current is 20.0A
Input Command: SOUT <status>[CR] Return value: OK[CR]	Switch on/off the output of PS <status>=0/1 (0=ON, 1=OFF)	Input command: SOUT0 [CR] Return value: OK[CR] Meaning: Switch on the output of PS
Input Command: VOLT <voltage>[CR] Return value: OK[CR]	Preset Voltage value <voltage>=000<??><Max-Volt> *Max-Volt value refer to product specification	Input command: VOLT127 [CR] Return value: OK[CR] Meaning: Set Voltage value as 12.7V
Input Command: CURR <current>[CR] Return value: OK[CR]	Preset Current value <current>=000<??><Max-Curr> *Max-Curr value refer to product specification	Input command: CURR120 [CR] Return value: OK[CR] Meaning: Set Current value as 12.0A
Input Command: GETS [CR] Return value: <voltage><current>[CR] OK[CR]	Get PS preset Voltage & Current value <voltage>=??? <current>=???	Input command: GETS [CR] Return value: 150180[CR] OK[CR] Meaning: The Voltage value set at 15V and Current value set at 18A
Input Command: GETD [CR] Return value: <voltage><current><status>[CR] OK[CR]	Get PS Display values of Voltage, Current and Status of CC/CV <voltage>=???? <current>=???? <status>=0/1 (0=CV, 1=CC)	Input command: GETD [CR] Return value: 150016001[CR] OK[CR] Meaning: The PS Display value is 15V and 16A. It is in CC mode.

Command code & return value	Function	Example
Input Command: PROM <voltage0><current0> <voltage1><current1> <voltage2><current2>[CR] Return value: OK[CR]	Save Voltage and Current value into 3 PS memory locations <voltageX>=??? <currentX>=??? (X is memory location number start from 0 to 2)	Input command: PROM111111022122033133[CR] Return value: OK[CR] Meaning: Preset Memory 0 as 11.1V and 11.1A Preset Memory 1 as 2.2V and 12.2A Preset Memory 2 as 3.3V and 13.3A
Input Command: GETM [CR] Return value: <voltage0><current0>[CR] <voltage1><current1>[CR] <voltage2><current2>[CR] OK[CR]	Get saved Voltage and Current value from 3 PS memory locations <voltageX>=??? <currentX>=??? (X is memory location number start from 0 to 2)	Input command: GETM [CR] Return value: 111111[CR] 122122[CR] 133133[CR] OK[CR] Meaning: PS return following preset value from 3 memory locations; Memory 0 is 11.1V and 11.1A Memory 1 is 12.2V and 12.2A Memory 2 is 13.3V and 13.3A
Input Command: RUNM <memory>[CR] Return value: OK[CR]	Set Voltage and Current using values saved in memory locations <memory>=0/1/2	Input command: RUNM 1[CR] Return value: OK[CR] Meaning: Set Voltage and Current using values saved in memory location 1

12. Appendix

HCS USB configuration for remote programming

This application note describes the procedure to configure the USB port for HCS remote programming application.

HCS remote programmable power supply with USB can connected to PC through USB cable.

USB to serial bridge design is used. When connected to PC, it will be converted as COM port shown in the following picture. e.g. COM3

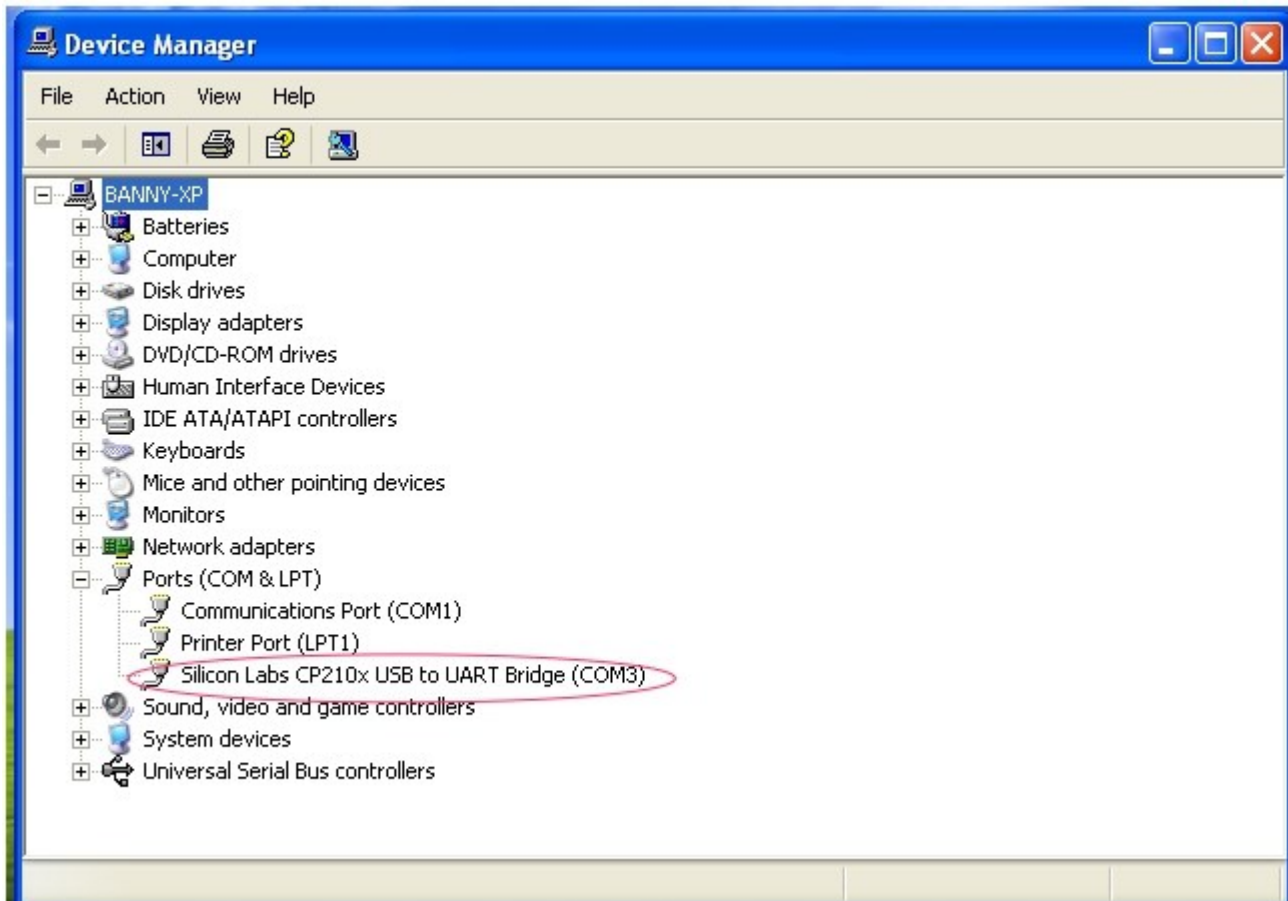

If the COM port does not come up, please check if the USB driver has been probably installed. The USB driver comes with HCS software CD. Make sure the CD has been load to computer first. Then it can program as stand COM port.

The default COM port setting;

baud rate : 9600
Data bits : 8 bit
stop bit : 1
Parity : None

The HCS then can be programmed for remote control etc. by the ASCII commands via the COM3. All the command sets are given in the user manual of the power supply.